

3 Lead Dual Band 3/4 dBi Mini Omnidirectional Antenna With 18" Plenum Pigtails and RPSMA Plug Connectors

Ventev's TerraWave 2.4/5 GHz Multiple-Input and Multiple-Output (MIMO) Omnidirectional Antenna is designed to be operated with any manufacturer's enterprise-class 802.11n MIMO access points (APs). The antenna features three integrated 2.4 and 5 GHz dual-band omni antennas in one enclosure, making it an ideal and aesthetically-pleasing antenna to support demanding applications in next generation IEEE 802.11n wireless communication systems. *All TerraWave antennas are covered by the Company's two-year TerraNet warranty program. For questions and to purchase product, contact Ventev, 800-851-4965 or sales@ventev.com.*

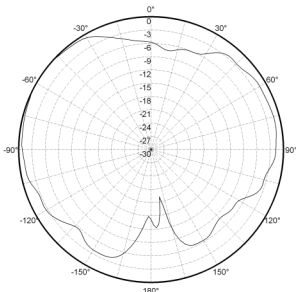

Specifications	
SKU	364146
Model	M603004001D1820MP
Frequency Range	2400 ~ 2483 / 5150 ~ 5850 MHz
Bandwidth	83 / 700 MHz
Gain	3 / 4 dBi
Vertical Beamwidth	90°/160°
Horizontal Beamwidth	360°
VSWR	≤ 2.0
Nominal Impedance	50 Ohms
Polarization	Vertical
Max Power	2 Watts
Connector	RPSMA Plug
Pigtail Length	18" Plenum
Dimensions	5.9" x 2.9" x 1.0"
Weight	1.55 lbs
Operating Temperature Range	-40°F to +158°F
Lightning Protection	DC Ground
Hole Dia. Required to Mount Antenna	1"



E-Plane Pattern

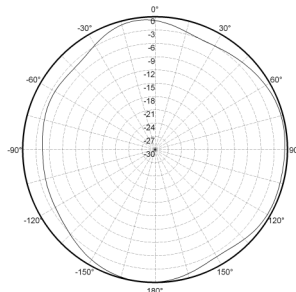

H-Plane Pattern

2.4 GHz

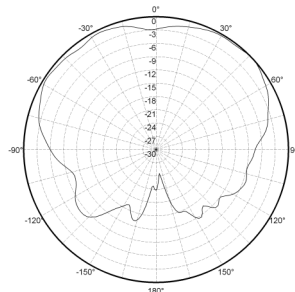

E-Plane Pattern

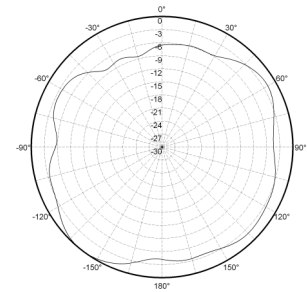

H-Plane Pattern

5 GHz

3 Lead Dual Band 3/4 dBi Mini Omnidirectional Antenna With 18" Plenum Pigtails and RPSMA Plug Connectors

Mounting Information for M603004001D1820MP

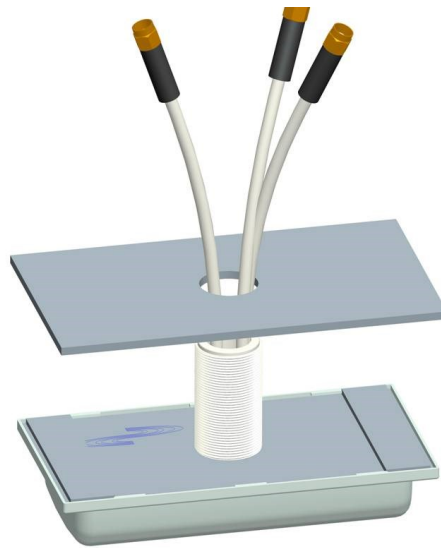

www.ventev.com

1" Diameter Hole

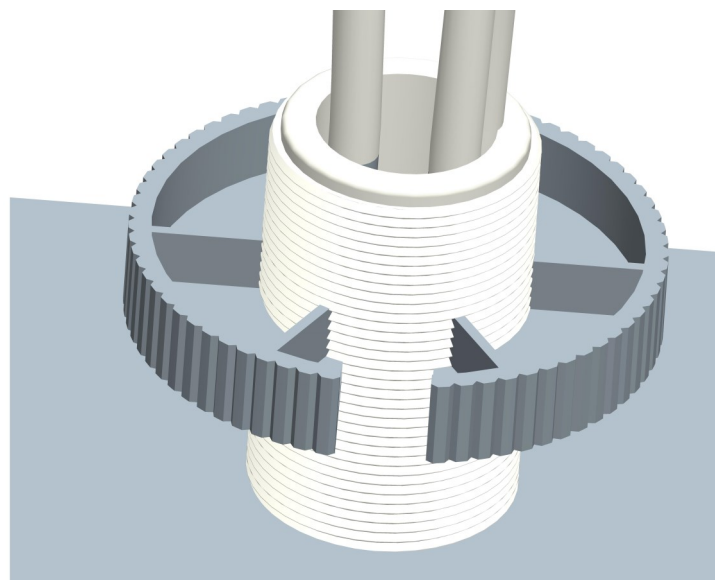
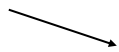

3 Lead Dual Band 3/4 dBi Mini Omnidirectional Antenna With 18" Plenum Pigtails and RPSMA Plug Connectors

Dimension Information for M603004001D1820MP

