

Installation & Mounting Manual

Aruba T-Bar Clip

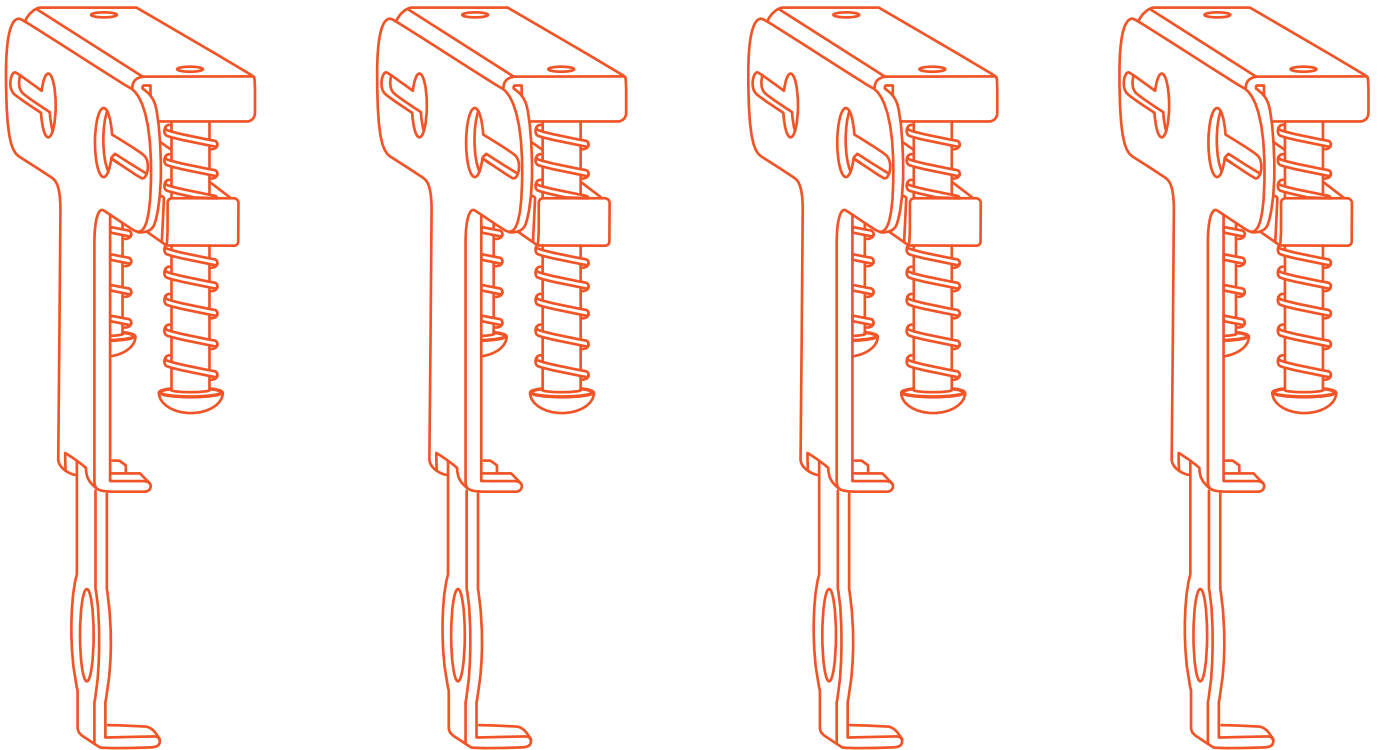

MFG Part Numbers & SKUs:

Aruba T-Bar Clip

- MFG Part #: ARUBA-TBAR-BKT-1
- SKU: 278472

Aruba T-Bar Clip, 5 Pack

- MFG Part #: ARUBA-TBAR-BKT-5
- SKU: 246331

Aruba T-Bar Clip, 10 Pack

- MFG Part #: ARUBA-TBAR-BKT-10
- SKU: 219030

Ventev Aruba T-Bar Clip Instructions

The Ventev Aruba T-Bar Bracket is used to attach Aruba access points to 9/16 in. and 15/16 in. flat T-bar grids. As shown in the figure below, the two (2) M4 screws included with the access point are used to attach the Ventev Aruba T-Bar Clip to the access point.

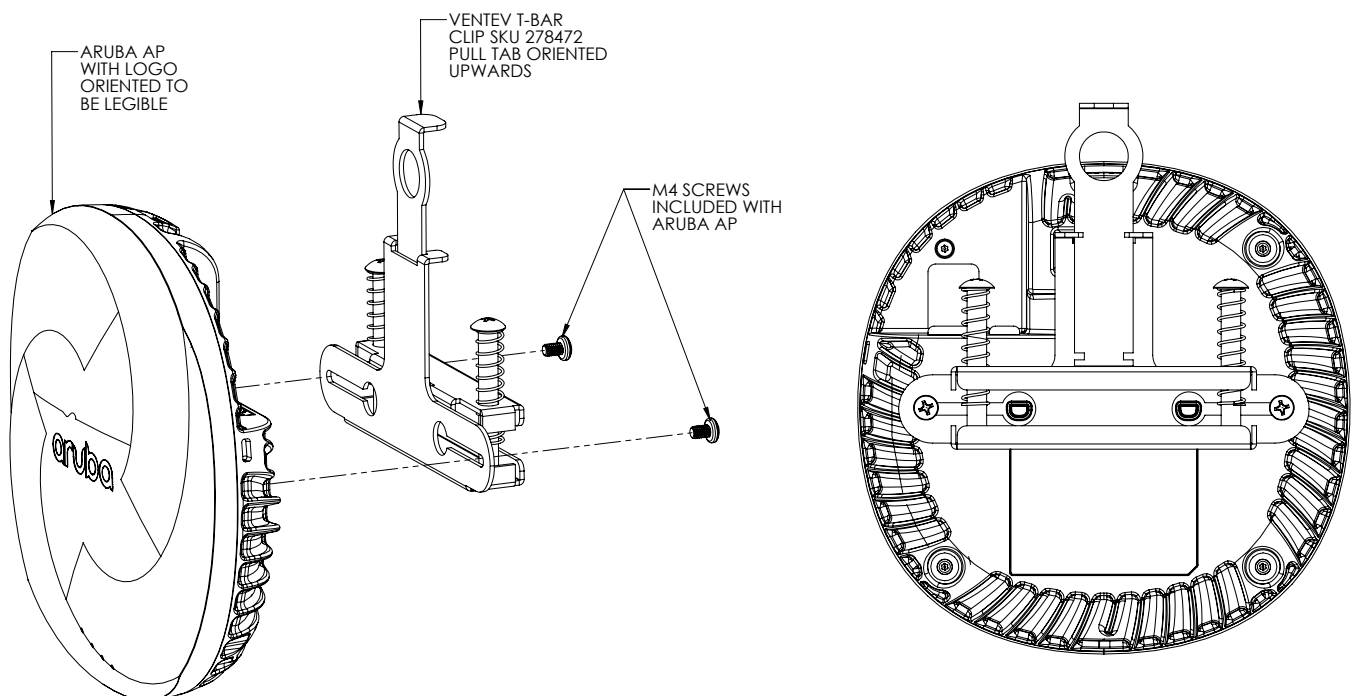

Step 1

First, remove any factory brackets from the access point prior to Ventev Aruba T-Bar Clip installation. Retain the two (2) M4 screws used to hold the factory bracket in place.

Step 2

Orient the access point so that the logo is legible and orient the pull tab of the T-bar bracket so it is facing upwards.

Step 3

Secure the Aruba T-Bar Clip to the Aruba access point using the two (2) M4 screws included with the access point.

Step 4

Pull the pull tab of the T-bar bracket and install the access point onto the T-bar, ensuring that both sides of the T-bar are properly seated in each channel of the Aruba T-Bar Clip, as pictured below.



There are certain Aruba access points where the mounting holes on the access point are underneath the t-bar channel (see images below).

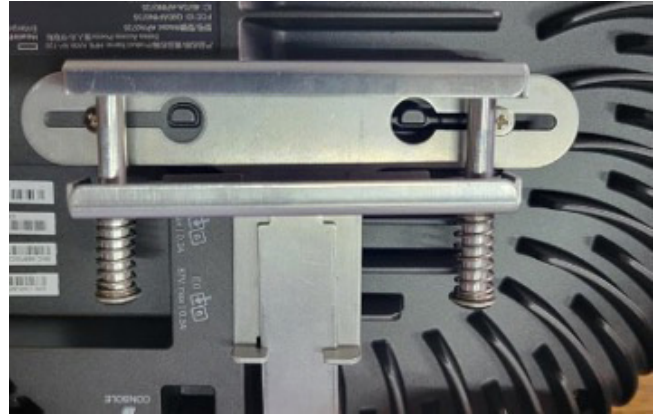
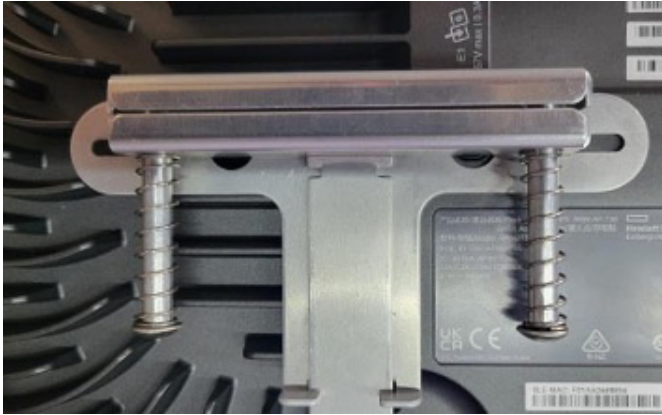

Step 5

For this scenario, we are including a 0.59 in. diameter x 1.5 in. (15 mm diameter x 38 mm) plastic cylinder to act as a bite block to hold the clip open so it can be properly secured to the access point. To install the bite block into the Aruba T-Bar Clip, place the bite block on a flat surface, as pictured below.



Step 6

Invert the Aruba T-Bar Clip as pictured below.

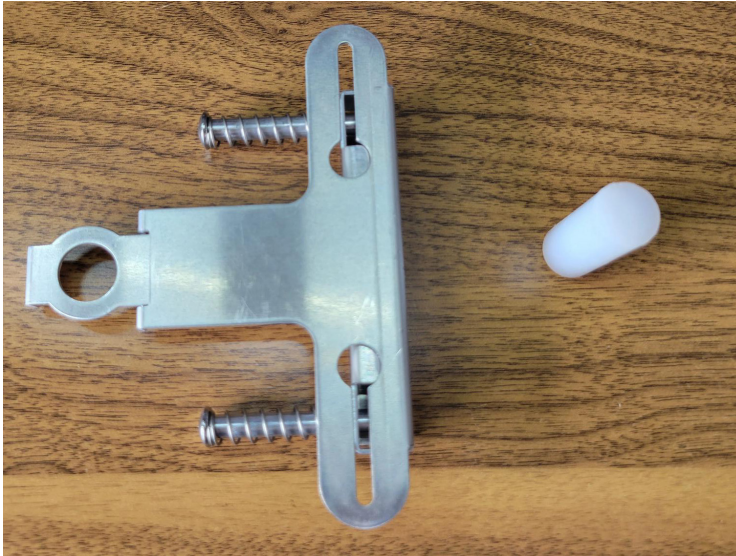

Step 7

Secure your fingers to the outside of both sides of the clip base and pull the pull tab to open the Aruba T-Bar Clip.



Step 8

When the clip opens, place the opening of the T-bar clip over the bite block cylinder, ensuring that the bite block is centered.

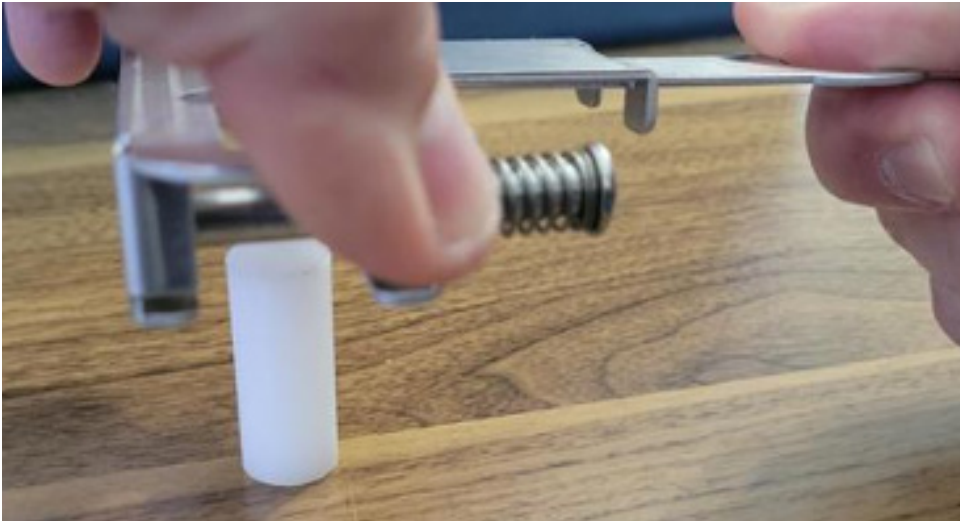

Step 9

Once centered, lower the Aruba T-Bar Clip over the bite block until the top of the bite block sits flat against the inside of the clip base.

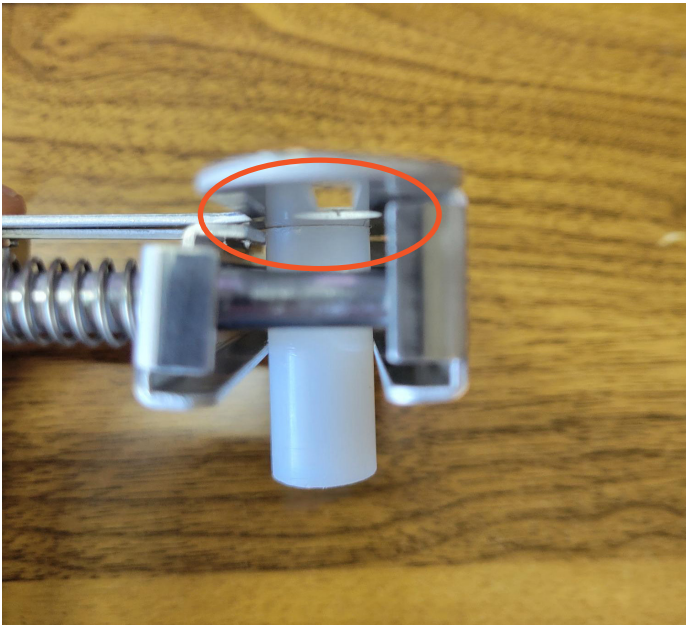

Step 10

Slowly close the T-bar clip onto the bite block.

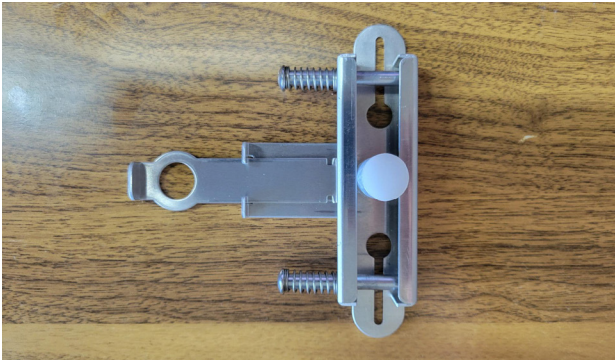

Step 11

Follow steps 1-3 above.

Step 12

Once T-bar is installed, secure the access point and pull the pull tab and remove the bite block from the T-bar clip.

Step 13

Once the clip is installed onto the access point, pull the pull tab of the T-bar bracket and remove the bite block.

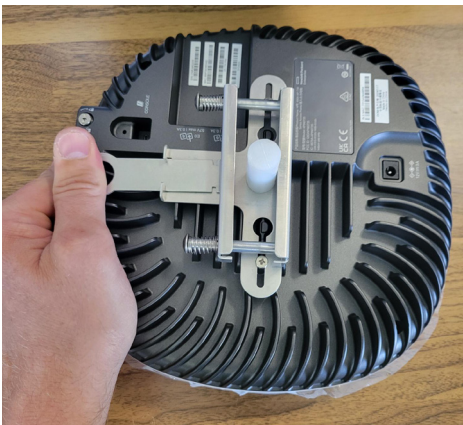

Step 14

Complete step 4 above.



11126 McCormick Road,
Hunt Valley, MD 21031
800-851-4965
sales@ventev.com

ventevinfra.com

