

2.4/5 GHz 6 dBi Wi-Fi Nano Patch Antenna

With 4 RPSMA Male Connectors

ventev®

Connect, Protect, and Enable™

Ventev's 6dBi Small Form Factor Nano Patch Antenna delivers outstanding Wi-Fi performance in a very small package and is ideal for space constrained environments or environments that place a premium on aesthetics. The versatile Nano Patch Antenna is used indoors and can be mounted on walls or ceiling tiles.

Specifications

SKU	221369
Manufacturer Part Number	M6060060D3D3602NS
Operating Frequency Range	2.4/5 GHz
Gain	6 dBi
Polarization	2 x Horizontal, 2 x Vertical
Vertical Beamwidth	90° ± 10°
Horizontal Beamwidth	85° ± 15°
VSWR	2:1 Nominal
Nominal Impedance	50 Ohms
Max Input Power	2 W
Number of Ports	4
Length of Lead	36 in pigtails
RF Connector	RPSMA Male
Application	Indoor
Dimensions	4 x 4 x 1 in
Weight	0.98 lb
Mounting Method	Ceiling/Wall Mount



All product specifications are subject to change without notice or obligation.

2.4/5 GHz 6 dBi Wi-Fi Nano Patch Antenna

With 4 RPSMA Male Connectors

ventev®

Connect, Protect, and Enable™

Mount Information

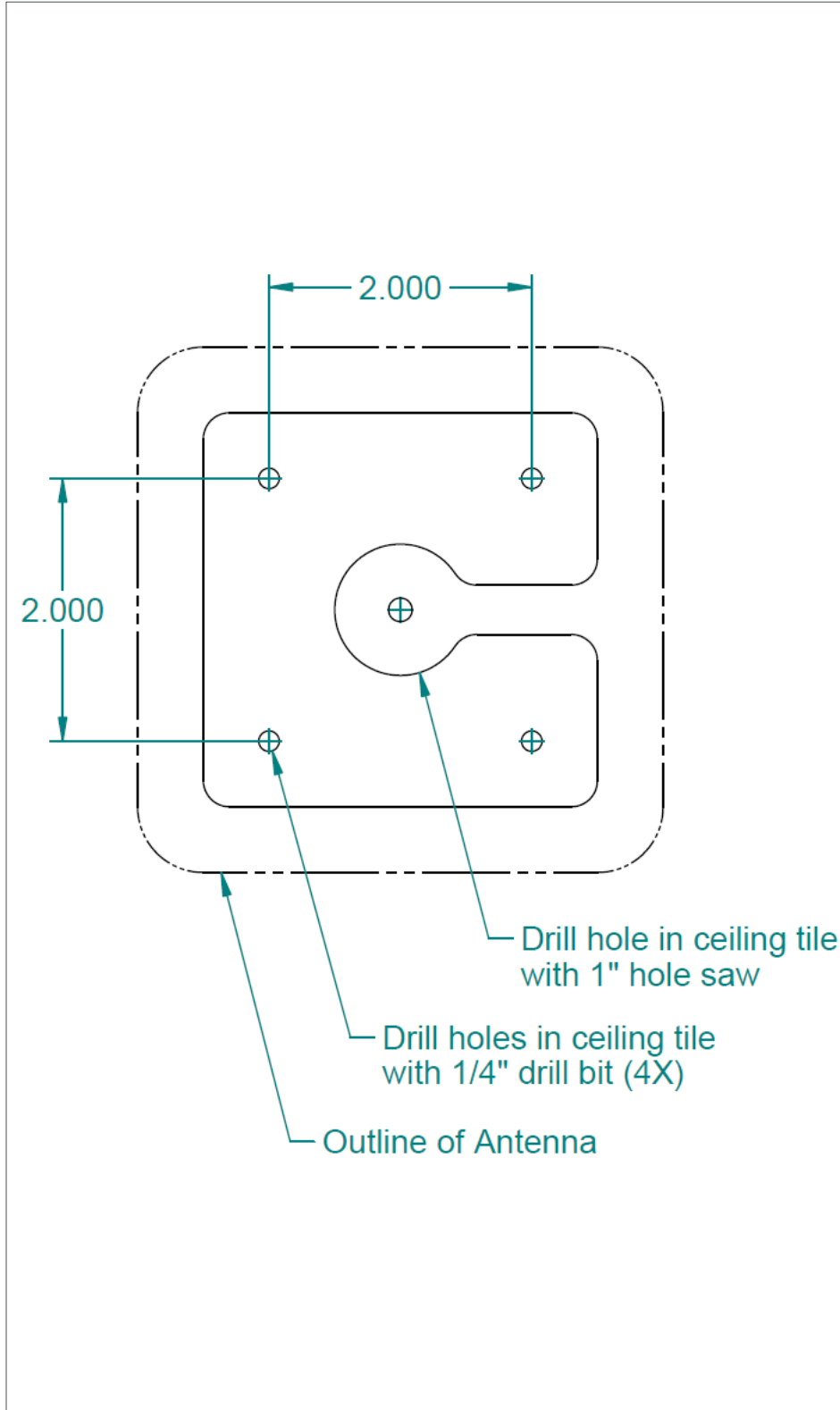

Radiation Patterns

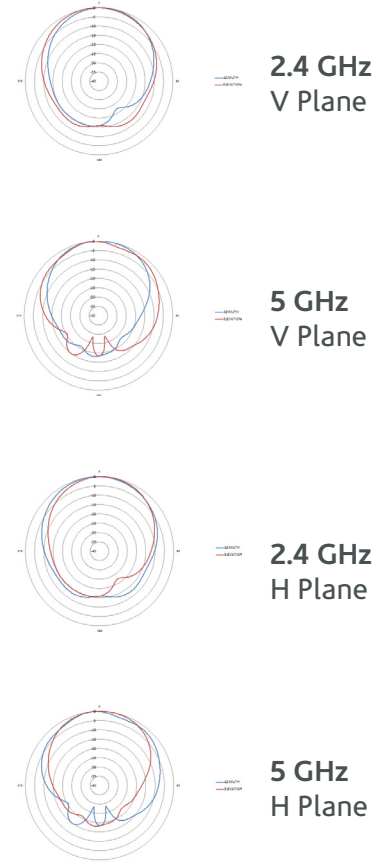

All product specifications are subject to change without notice or obligation.