

2.4/5/6 GHz 13 dBi Wi-Fi Patch Antenna

with 4 N Female Connectors

ventev®

Connect, Protect, and Enable™

Ventev's high-density 2.4/5/6 GHz 13 dBi Patch Antenna is designed for wireless networks operating in the 2.4, 5, and 6 GHz frequency range in both indoor and outdoor applications. The antenna uses a narrow 35-degree beamwidth at 2.4/5/6 GHz, minimizing channel-to-channel interference which in turn leads to increased capacity.

Specifications

SKU	606346
Manufacturer Part Number	M7130130MP1D3607D
Operating Frequency Range	2.4/5/6 GHz
Gain	13 dBi
Polarization	Vertical/Horizontal
Vertical Beamwidth	35°
Horizontal Beamwidth	35°
VSWR	≤ 2.0
Nominal Impedance	50 Ohms
Max Input Power	50 W
Number of Ports	4
RF Connector	N Female
Application	Indoor/Outdoor
Operating Temperature	-22° to 158° F
Dimensions	14.96 x 14.96 x 1.3 in.
Weight	5.8 lbs.
Mounting Method	Mast
Bandwidth	100/700/1200 MHz
Pole Diameter	1.97 x 4.7 in.
Isolation	≥ 25 dB



All product specifications are subject to change without notice or obligation.

2.4/5/6 GHz 13 dBi Wi-Fi Patch Antenna

with 4 N Female Connectors

Mount Information

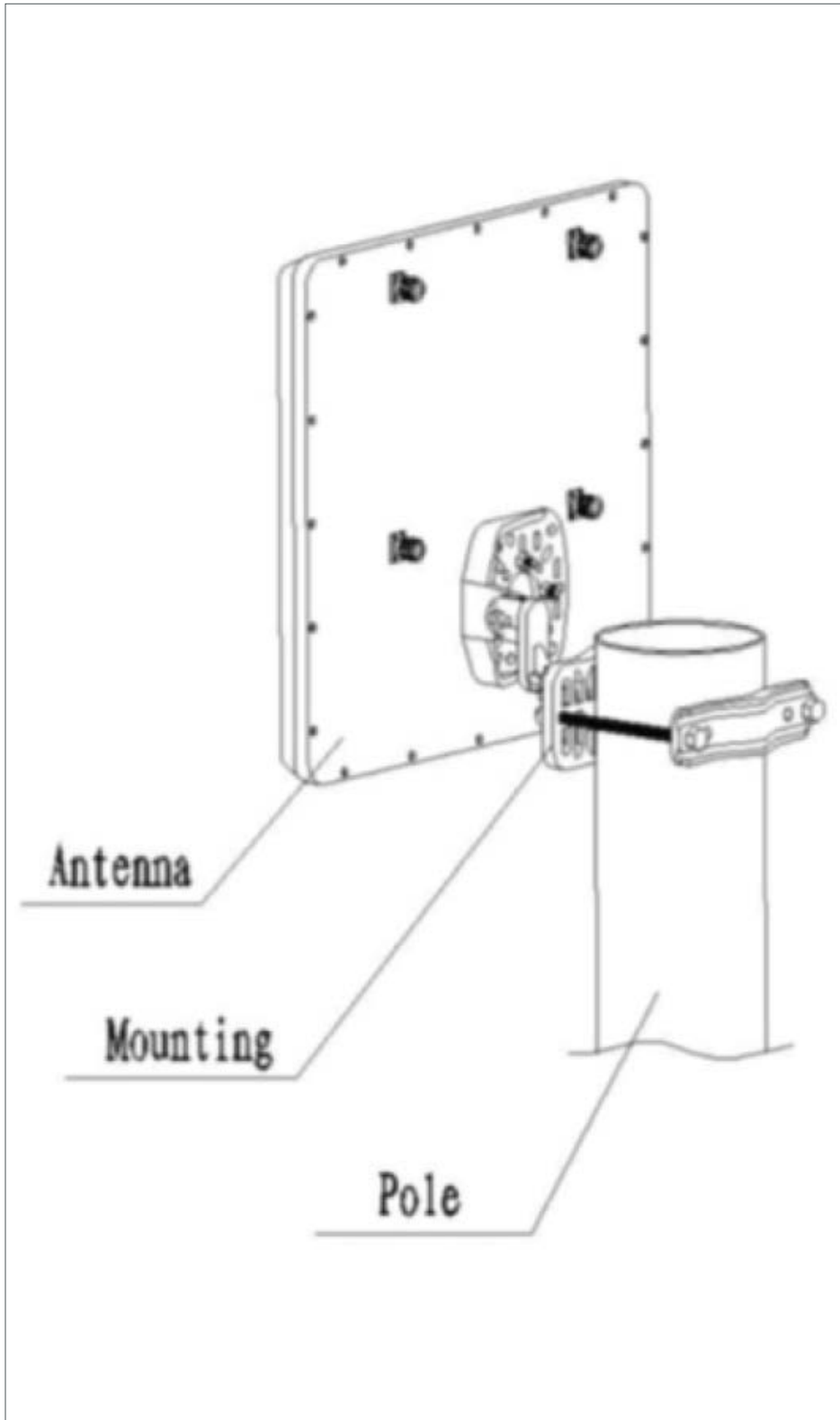

Radiation Patterns

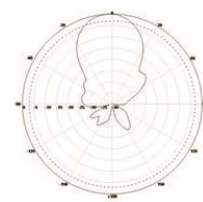

2.4/5/6 GHz
H Plane

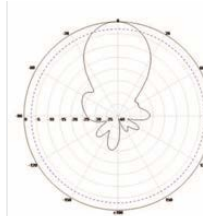

2.4/5/6 GHz
E Plane



All product specifications are subject to change without notice or obligation.